

ekl[i]pse



Instruction Manual

SONORO

sonoro audio GmbH & Co. KG

Unter Goldschmied 6
50667 Köln
Germany
fon +49 221 - 16 79 29 - 0
fax +49 221 - 16 79 29 - 290
info@sonoro-audio.com
www.sonoro-audio.com

12/08

The manufacturer continuously works on the further development of all types and models.

We ask for your understanding that changes of the scope of delivery in regard to form, components and technology are therefore possible at any time. The information, illustrations and descriptions in this manual therefore shall not constitute an entitlement to any claims.

Replication, copying or translation, even in parts, is not permitted without the written consent of the manufacturers.

The manufacturer explicitly reserves all rights pursuant to the law governing the copyright.

Subject to changes.

iPod is a trademark of Apple Inc., registered in the US and in other countries.

Apple is not responsible for the functionality of this device or its compliance with the safety guidelines.

Contents

1.	Introduction	5
2.	Safety Instructions	6
2.1	Symbols in this Operating Manual	6
2.2	Intended Use	6
2.3	Children and Persons with Limited Cognitive Abilities	6
2.4	Power Supply	7
2.5	Batteries	7
2.6	Laser	8
2.7	Transport	8
2.8	Environmental Conditions	8
2.9	Operation	9
2.10	Use of Headsets	9
2.11	Defect	9
2.12	Cleaning	9
2.13	Disposal	10
3.	Scope of Delivery	11
4.	Supported Formats	12
5.	Unpack Device and Start Operation	13
5.1	Unpack Device	13
5.2	Insert Batteries	13
5.3	Establish Power Supply	14
5.4	Connect Antenna	15
5.5	Prepare Remote Control	15
5.6	Prepare iPod Docking Station	16
5.7	Connect Headset	16
6.	Controls and Connectors	17
7.	Set Basic Functions	22
7.1	Set Display Language	22
7.2	Set the Brightness of Display and Click Wheel	23
7.3	Set Time Format	24
7.4	Set Time	24
7.5	Set the Sound	25
7.6	Set Sleep Timer	25
7.7	Reset Device to Factory Setting	26
8.	Alarm Function	27
8.1	Set Alarm Time	27
8.2	Alarm signal via Radio, CD or iPod	28
8.3	Set Alarm Volume	29
8.4	Turn Alarm On and Off	29
8.5	Turn Off Alarm Function After Alarm Goes Off	30
8.6	Set Interval for Repeat Alarm Function (Snooze)	30
9.	General Functions of the Audio Playback	31
9.1	Set Volume	31
9.2	Mute Playback	31
9.3	Select Playback Mode	31

Contents

10. Radio Playback.....	33
10.1 Search Station.....	34
10.2 Preset Station.....	34
10.3 Retrieve Preset Station	35
11. CD Playback.....	36
12. iPod Playback.....	38
13. AUX Playback.....	40
14. Trouble Shooting.....	41
15. Technical Data.....	43
16. Warranty.....	45

1. Introduction

Congratulations on purchasing a sonoro eklipse.

This operating manual provides you with all information concerning the correct and safe operation of the device.

- Please read this operating manual in its entirety before using the device.
- Keep these instructions at a safe place.
- In case you pass this device on to a third party, please also include the operating manual.
- Non-compliance with this manual may lead to serious injuries and damage to the device.
- We may not be held liable for damage that was caused due to non-compliance with this operating manual.
- Please take special note of the chapter „Safety Instructions“ on page 6.

The illustrations in this operating manual serve the purpose to visualize processes and always appear in front of the descriptions which they refer to.

Enjoy your device!

2. Safety Instructions

2.1 Symbols in this Operating Manual

Important information relative to your safety is especially marked. It is imperative that you adhere to this information to avoid accidents and damage to the device:



RISK!

Warning concerning risks to your health and indication of potential risk of injury.



WARNING!

Indicates potential risks for the device and other objects.



NOTE!

Highlights tips and information for you.

2.2 Intended Use

The device is only for private use. It is not suitable for commercial use. The device is exclusively intended for the following tasks:

- Play back radio signals
- Play audio and MP3 CDs
- Play audio directly from an iPod, charging function for the iPod
- Play audio for external devices that are connected via AUX.

Any other use is not intended and is prohibited. We may not be held liable for damage caused through unintended use.

2.3 Children and Persons with Limited Cognitive Abilities

- Do not leave the device unattended and do not use it if children or people are in close range who may not be able to assess the associated risks.
- Persons (including children) who based on their physical, sensory or mental capacities or their inexperience or lack of knowledge are not able to safely use this device may not use this device without supervision or without instructions provided by a responsible person. Please store this device at an inaccessible location.
- Packaging material may not be used for playing. It presents a suffocation risk.

2.4 Power Supply

The device is powered by electricity; therefore there is always a risk of an electric shock. For this reason, especially adhere of the following instructions:

- Never touch the power plug with wet hands.
- If you want to pull the plug from the power outlet, always pull directly on the plug. Never pull on the cable, it may rip.
- Please ensure unobstructed access to the utilized power outlet at all times, so that the plug can be pulled immediately in case of an emergency.
- Please ensure that the electric cord is not bent, wedged or rolled over. Install the electric cord so that it cannot become a tripping hazard and so that it is out reach for children.
- Only use extension cords that are designed to handle the power input of the device.
- Keep the device away from rain and moisture as well as from any heat sources
- Only operate the device when the electric voltage on the type label of the device and on the plug match the voltage of your electrical outlet. An incorrect voltage can destroy the device.
- If you will not use the device for a longer period of time, separate the device completely from the power supply system to prevent a potential fire hazard. For that, pull the plug from the electrical outlet.

2.5 Batteries

- Remove batteries/ rechargeable batteries from the battery compartment as soon as they are empty or if the device will not be used for a longer period of time.
- Do not throw the batteries/ rechargeable batteries in a fire and never make them subject to high temperatures.
- Never try to recharge batteries. Do not try to open or short-out batteries/ rechargeable batteries. This may present an explosion hazard.
- Liquid that leaks during the incorrect use of the batteries may cause skin irritations. In the event of direct contact with the liquid, wash it off with plenty of water. When the liquid gets into the eyes, do not rub the eyes. Flush the eyes with water for 10 minutes and immediately seek medical assistance.

2.6 Laser

This device has been classified as a class 1 laser device. Laser beams can damage the eyes. Therefore, please adhere to the following:

- Do not attempt to disassemble the device.
- Risk prevention: Maintenance and repair work must only be performed through the manufacturer or the manufacturer's respective customer service.



2.7 Transport

- To avoid damage to the inserted medium, please remove it from the device prior to transport/shipping.
- Store the device during the transport in a vehicle in such a fashion that the occupants are not endangered.
- If you ship the device, pack it in the original packaging. Therefore, keep the packaging.

2.8 Environmental Conditions

The safe operation of the device requires appropriate environmental conditions. Therefore, please adhere to the following:

- Protect the device from exposure to effects imposed by the weather. Never use it outside and never set it up at locations that are subject to significant direct sunlight.
- Never place the device on or in immediate proximity of fire or heat sources such as for example burning candles, stove tops, ovens etc.
- Set up the device so that sufficient air supply is guaranteed. This will avoid heat accumulation on the inside of the device. Always keep a minimum distance of 10 cm to other devices or walls.
- Protect the device from strong mechanical vibrations and place it on solid surfaces.
- Protect the remote control from effects imposed by the weather, moisture and high temperatures (e.g. from direct sunlight).
- Protect the device from splashing or dripping water. Never place a container filled with liquid next to or onto the device.
- Never install/ remove the batteries that came with the device in an environment that bears the potential risk of explosions (e. g. gas station areas, fuel lines, gasoline storage areas, areas where the air may contain chemicals or explosive particles/dust (e. g. flour dust or metal powder) or areas in which you have been instructed to turn off the engine of your vehicle). This may present an explosion hazard.

2.9 Operation

- Never insert any objects into the CD slot of the device other than the approved CDs. Special formats, mini CDs etc. will cause damage to your device.
- Never place any other than the approved iPod types into the iPod docking station.

2.10 Use of Headsets

- Always decrease the volume of the device before putting on the headset. Only increase the volume to the desired level after the headset is in the correct position.
- Do not set the volume too high when using the headset. If you hear a permanent noise or a background sound in your ears (ringing), decrease the volume or stop using the headset.
- Even if your headset is designed so that you are still able to hear exterior sounds, never set the volume to such a high level that you are no longer able to be aware of your surroundings.

2.11 Defect

Never try to fix your device on your own if it becomes defective.

- If the power plug, the adapter or the power cord of this device is damaged, they must be replaced by the manufacturer or the manufacturer's customer service to avoid the risk of electric shock.
- If liquid gets into the device or if the device was dropped or otherwise damaged, it must be checked by an authorized dealer. Separate the device from the power supply and contact an authorized dealer.

2.12 Cleaning

- Only use the cloth that came with the packet or another dry, soft cloth to clean the exterior surfaces of the device. Never use any abrasive or dissolvent cleaning agents, because these may damage the surface of the device.
- If the device is extremely dirty, it may also be wiped down with a slightly moist cloth and dried with a dry, soft cloth.

2.13 Disposal



Devices that are marked with the symbol on the left may not be disposed of with the regular household trash, but must be dropped off at a recycling center for electric and electronic devices.

Batteries/ rechargeable batteries may contain toxic heavy metals and are subject to special refuse treatment. Drop off the batteries/rechargeable batteries at a communal collection site or bring them to a specialized store for disposal.

Please consider that your electronic entertainment device is subject to the European guideline 2002/96/EC for the reduction of electronic waste.

- Therefore please note that you are not permitted to dispose of your device in your household waste.
- You can receive information regarding the disposal of old devices at the municipal administration, the waste disposal administration and the store where you purchased this product
- You can drop off your device free of charge at communal collection points.
- With the proper disposal of old devices you prevent environmental damage and don't damage your health.

3. Scope of Delivery

Numerous accessories are necessary to receive the radio frequencies or to connect additional devices. They are part of the packet of the sonoro eklipse.

- sonoro eklipse (with bag)
- Remote control
- Power supply unit with universal adapter
- FM antenna
- AM antenna
- AUX cable
- iPod dock adapters
- 2 batteries 1.5 volt alkali manganese, size: Mignon LR06/AA
- Cleaning cloth
- Gloves
- Operating manual

4. Supported Formats











Supported CD formats:

- Compact Disc Digital Audio CD-DA, CD-R*, CD-RW*
 (* Playback depends on the CD quality and recording quality)

Supported audio formats:

- CD-DA, MP3, WMA

Compatible iPod types with required operating manual:

iPod model	Adapter T2/ A	Adapter T2/ B	iPod adapter from scope of delivery
 iPod 3rd generation	10 GB, 15 GB, 40 GB	20 GB, 30 GB	
 iPod mini	4 GB, 6 GB		
 iPod 4th generation	40 GB	20 GB	
 iPod 4th generation (color display)	20 GB, 60 GB	30 GB, 40 GB	
 iPod 5th generation (video)	30 GB	60 GB, 80 GB	
 iPod classic		80 GB, 160 GB	
 iPod nano 1st generation	1 GB, 2 GB, 4 GB		
 iPod nano 2nd generation (aluminum)			2 GB, 4 GB, 8 GB
 iPod nano 3rd generation (video)			4 GB, 8 GB
 iPod nano 4th generation (video)			8 GB, 16 GB
 iPod touch			8 GB, 16 GB, 32 GB

5. Unpack Device and Start Operation

You may only use connecting cables and external devices that comply with this device in regard to electromagnetic compatibility and insulation quality. This device fulfills all relevant standards and guidelines in conjunction with US and European regulation. In the event of a device change that has not been coordinated with the manufacturer, the compliance with the standards and guidelines is no longer guaranteed. Only use the accessories listed by the manufacturer.



RISK!

Playing with packaging material presents a suffocation risk!

Playing with packaging material presents a suffocation risk. Keep the packaging material out of the reach of children and persons who may not be able to assess the risks.

5.1 Unpack Device

All parts of the device come in one box.

1. Unpack the device and all accessories and check the content for completeness and proper condition.



NOTE!

In case you detect damage due to transportation or if parts of the packet are missing, contact your dealer immediately.

2. Set up the device at a suitable location. Adhere to the security instructions concerning the environmental conditions on page 6.

5.2 Insert Batteries

The batteries ensure the functioning of the clock in the event of power failure.



RISK!

Injury hazard due to incorrect handling of batteries!

Batteries must be treated with special care.

- Remove batteries/ rechargeable batteries from of the battery compartment as soon as they are empty or if the device will not be used for a longer period of time.
- Do not throw the batteries/ rechargeable batteries into a fire and never make them subject to high temperatures.

- Do not try to recharge standard batteries. This may present an explosion hazard. Do not try to open or short-out the batteries/ rechargeable batteries.
- Leaking liquid in conjunction with an incorrect use of the batteries may cause skin irritations. In the event of contact with the liquid, wash it off with plenty of water. If the liquid gets into the eyes, do not rub the eyes. Flush the eyes with water for 10 minutes and immediately seek medical assistance.

1. Open the battery compartment lid by pressing down the clamp locking mechanism.
2. Insert the batteries that were delivered with the packet (1.5 v, AA) into the battery compartment according to the polarity as shown on the imprint on the back of the device.
3. Insert the battery compartment lid again.

5.3 Establish Power Supply

The device is powered via the power supply unit that comes with the packet. The power supply unit with the universal adapter must be assembled prior to its first use.



RISK!

Injury hazard due to inappropriate handling!

Improper handling of the universal power supply unit may result in the risk of an electric shock.

- Make sure that the power supply unit and the universal adapter are always firmly connected with each other.
- Pull the power supply unit with the universal adapter from the outlet in a straight motion so that the adapter will not break off the mounting.



WARNING!

Property damage due to incorrect voltage connection

Connection values that exceed the permissible maximum values of the device can destroy the device.

- Only use the power supply unit that came with the device.
- Only operate the device when the voltage indicated on the power supply unit matches the voltage on your electrical outlet.

1. Slide the universal adapter onto the power supply unit until it has snapped into position.
2. Plug the connecting plug of the power supply into the 12V $\overline{=}$ 2A DC port on the back of the device.
3. Plug the power plug into an electrical outlet.

5.4 Connect Antenna

The sonoro eklipse has an internal antenna to receive the radio signal in the FM frequency range. If the reception is not sufficient at the set-up location or if you would like to receive additional FM or AM stations, attach the FM or AM antenna that came with the packet or hook up a respective home antenna.



NOTE!

The FM frequency wave band corresponds with the ultra short wave range and falls into the VHF band II between 87.5 MHz and 108.0 MHz. The AM frequency wave band corresponds with the medium wave range and falls between 522 kHz and 1620 kHz for AU-3000, and 520 kHz and 1710 kHz for AU-3001.

FM antenna or home antenna

1. Plug the FM antenna that came with the packet or your home antenna into the FM antenna port on the back of the device.
2. Turn the FM switch from INT to EXT.
3. Adjust the FM antenna that came with the packet so that you have an optimal reception.



NOTE!

If no external antenna is connected to the FM port, the switch should be set at INT to ensure the best possible reception via the internal antenna.

AM antenna

1. Plug the AM antenna that came with the packet into the AM antenna port on the back of the device.
2. Adjust the position of the AM antenna for an optimal reception.

5.5 Prepare Remote Control

The remote control of sonoro eklipse already includes a battery. The protective foil must be removed prior to the first use.

1. Carefully pull out the insulating strip that sticks out of the battery component on the bottom of the device. It is not necessary to open the battery component to do so.

5.6 Prepare iPod Docking Station

Two universal dock adapters are included in the packet to ensure the secure positioning of your iPod in the docking station. Refer to the table on page 12 to find out which dock adapter is to be used.



WARNING!

Physical damage through improper operation!

Pointy or sharp edged objects may damage the PIN connector.

- Do not use any such objects to insert or remove the dock adapter.

Insert dock adapter

1. Press the lid of the docking station to unlock it and then slightly fold back the lid.
2. Carefully insert the appropriate dock adapter for your iPod into the docking station so that the opening on the side faces toward the back.
3. Carefully push on the back edge of the dock adapter until it snaps into place.

Remove dock adapter

If you want to remove the dock adapter, insert your fingernail into the back slit on the side of the dock adapter and carefully pull it up and out of the docking station.

5.7 Connect Headset

The device supports the connection with headsets featuring 3.5-mm stereo jacks (not included in the packet).



RISK!

Risk of injury due to improper use of headsets!

An improper use of headsets can lead to significant accidents and cause damage to one's health.

- Do not set the volume too high when using the headset.
- Even if your headset is designed so that you are still able to hear exterior sounds, never set the volume to such a high level that you are no longer able to be aware of your surroundings.

1. Before you connect the headset, set the volume to the minimum level. For that, press the VOL- button.
2. Insert the headset jack into the headset port on the backside of the device .
3. Slowly increase the volume by pressing the Vol+ button.

6. Controls and Connectors

The controls of the sonoro eklipse facilitate fast and easy access to all functions. The operating functions are also accessible via the remote control unit.

eklipse front:

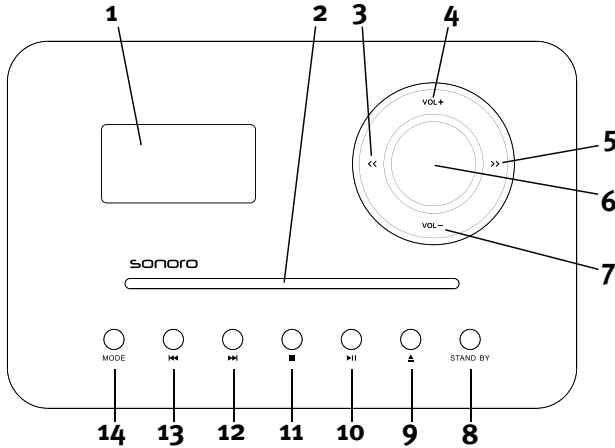

- | | | |
|-----------|-------------------|---|
| 1 | OLED display | Shows the current time when the device is turned off, provides information about the active mode when the device is turned on. |
| 2 | CD slot | CD slot only accepts CDs when the device is turned on, ejection of CDs possible when the device is in stand-by mode. |
| 3 | << (Previous) | FM/AM: Search stations in lower frequency range.
CD/iPod: Previous/Rewind. |
| 4 | VOL+ | Menu selection: Switch to the next higher menu, exit Setup Menu.
All playback modes: Increase volume |
| 5 | >> (Forward) | Menu selection (Setup Menu and iPod): Switch to previous menu setting (up).
FM/AM: Search stations in higher frequency range.
CD/iPod: Next/Fast-forward. |
| 6 | Menu button | Press briefly: Open/Start highlighted menu item
Press and hold: Open Setup Menu. |
| 7 | VOL- | All playback modes: Decrease volume
Menu selection (Setup Menu and iPod): Switch to next menu setting (down). |
| 8 | STAND BY | Turn device on/off. |
| 9 | Eject | Eject CD |
| 10 | Start/Pause | CD/iPod: Start/Pause playback. |
| 11 | Stop | CD: End playback.
iPod: Switch to the next higher menu. |
| 12 | Next/Fast-forward | CD/iPod: Press briefly: Play next title.
CD/iPod: Press and hold: Fast forward within title. |
| 13 | Previous/Rewind | CD/iPod: Press briefly: Play previous title.
CD/iPod: Press and hold: Rewind within title. |
| 14 | MODE | Switch to next play mode. |

eclipse top:

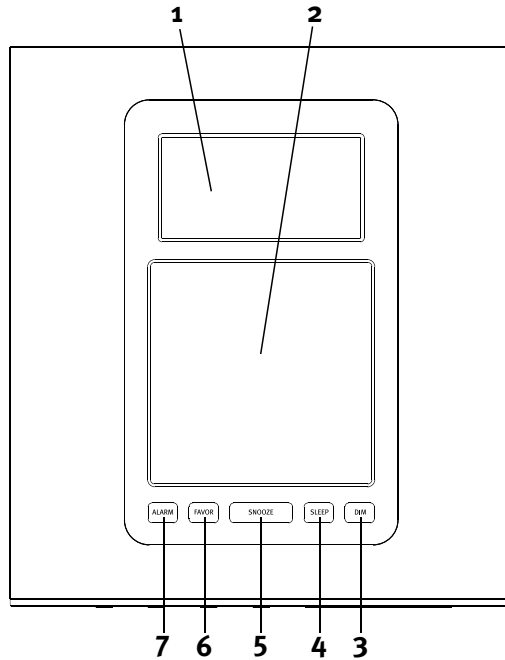

1 iPod dock

Plug in iPod with suitable dock adapter (refer to compatible iPod types on page 12). Open cover by briefly pressing it down.

2 Loudspeaker

Loudspeaker opening.

3 DIM

Open **Dimmer** menu to set the display and wheel lighting.

4 SLEEP

Press briefly: Turn on/off automatic turn-off (Sleep Timer).

5 SNOOZE

Press and hold: Open **Sleep Timer** menu to set the time after which the device is supposed to turn off automatically.

Press briefly (in play mode): Turn play mode on/off (Mute Setting).

6 FAVOR

Press briefly (in Alarm mode): Start repeat alarm (Snooze).

7 ALARM

Press and hold: Open **Snooze Setting** menu to set the repeat alarm time.

Save station.

Press briefly: Turn alarm functions on/off; end alarm.

Press and hold: Open **Set alarm** menu to select the alarm functions.

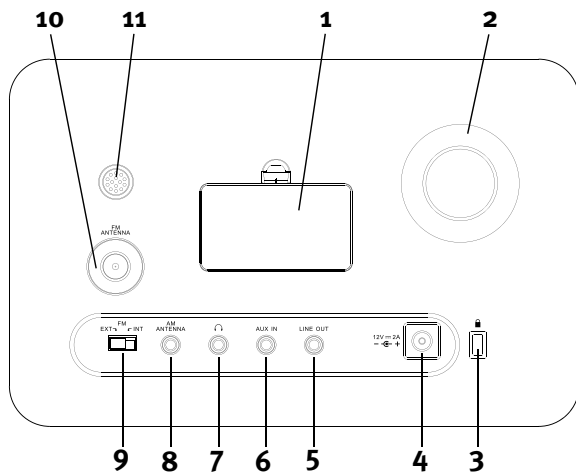
eclipse back:

- | | |
|------------------------------------|---|
| 1 Battery compartment | 2 batteries (1.5 V AA) ensure the continued operation of the clock in the event of power failure. |
| 2 Bass reflex opening | The distance to the next wall should measure at least 3 cm. |
| 3 Keylock | Connection for theft protection. |
| 4 Power supply connection | 12 V port for the power supply unit that came with the packet. |
| 5 LINE OUT | Port of the eclipse for external audio devices. |
| 6 AUX IN | Port for external audio devices. |
| 7 Headset | Port for a headset. |
| 8 AM ATENNA | Port for AM antenna that came with the packet. |
| 9 FM EXT/INT antenna switch | To switch setting when using an internal or external FM antenna. |
| 10 FM ANTENNA | Port for FM antenna that came with the packet. |
| 11 Signal transmitter | Sends alarm signal. |

Remote control:

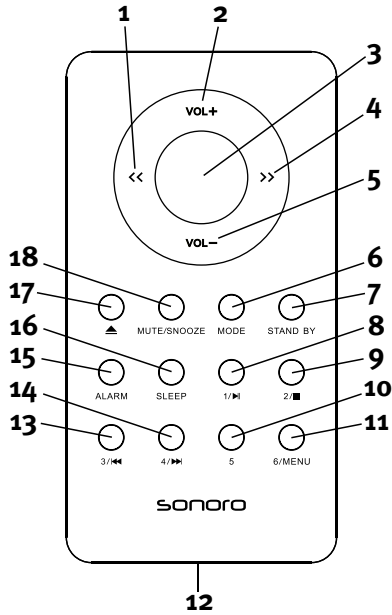

1 << (Previous)

FM/AM: Search for stations in lower frequency range.
CD/iPod: Previous/Rewind.

Menu selection: Switch to the next higher menu, exit Setup Menu.

2 VOL+

All playback modes: Increase volume

Menu selection (Setup Menu and iPod): Switch to previous menu setting (up).

3 Menu button

Press briefly: Open/start highlighted menu item

Press and hold: Open Setup Menu.

4 >> (Forward)

FM/AM: Search stations in higher frequency range.

CD/iPod: Next/Fast-forward.

5 VOL-

All play modes: Reduce volume

Menu selection (Setup Menu and iPod): Switch to next menu setting (down).

6 MODE

Switch to next play mode.

7 STAND BY

Turn device on/ off.

8 1/Start/Pause

FM/AM: Program button for radio station 1.

CD/iPod: Start/pause playback.

9 2/Stop

FM/AM: Program button for radio station 2.

CD: End play.

iPod: Switch to the next higher menu.

- 10** 5
FM/AM: Program button for radio station 5.
- 11** 6/MENU
FM/AM: Program button for radio station 6.
iPod: Open menu selection or switch to next higher menu.
- 12**
Battery compartment on the back
- 13** 3/Previous/Rewind
FM/AM: Program button for radio station 3.
CD/iPod: Press briefly: Play previous title.
CD/iPod: Press and hold: Rewind within title.
- 14** 4/Next/Fast-forward
FM/AM: Program button for radio station 4.
CD/iPod: Press briefly: Play next title.
CD/iPod: Press and hold: Fast-forward in title.
- 15** ALARM
Press briefly: Turn alarm function on/off. End alarm.
Press and hold: Open **Set Alarm** menu to select the alarm functions.
- 16** SLEEP
Press briefly: Turn on/off automatic turn-off (Sleep Timer).
Press and hold: Open **Sleep Timer** menu to set the time after which the device is supposed to turn off automatically.
- 17** Eject
Eject CD.
- 18** MUTE/SNOOZE
Press briefly (in play mode): Turn play mode on/off (Mute Setting).
Press briefly (in Alarm mode): Start repeat alarm time (Snooze).
Press and hold: Open **Snooze Setting** menu to set the repeat alarm time.

7. Set Basic Functions

The Setup Menu provides access to the functions and settings of the device.



NOTE!

You can set the clock, the alarm functions as well as the dimmer via the menu in the standby mode. First of all, turn on the device to access the Setup Menu with all functions.

1. Press and hold the Menu button of the eklipse or the remote control until the Setup Menu appears.

In the Setup Menu, the display shows the following information:



The arrow points to additional settings in the list.

2. Switch to the desired menu setting by pressing the VOL+ or VOL- button.
3. Briefly press the Menu button again to open the highlighted menu setting and enter the settings.
4. Press the << (Previous) button to switch to the next higher menu or to exit the Setup Menu.



NOTE!

If you are not processing any additional settings, the Setup Menu will be closed and the display switches back to the original mode again.

7.1 Set Display Language

The language of the menus as well as the playback display can be set individually.

1. Press and hold the Menu button of the eklipse or the remote control until the Setup Menu appears.

2. Select the Language menu item.



3. Select the desired language and press Menu button again.

7.2 Set the Brightness of Display and Click Wheel

The display brightness and the wheel lighting have three separate levels that can be set independently from each other.

This function is also available in the standby mode of the device.



NOTE!

The life expectancy of an OLED display diminishes with an increase of brightness. It is therefore recommended to set the brightness to low or medium.

1. Press and hold the Menu button of the eklipse or the remote control until the Setup Menu appears, and select the **Dimmer** menu item.

or

Press the DIM button on the top of the device.



2. Select **Display** and press VOL+ or VOL- to adjust the brightness of the display. Select **Light** and press VOL+ or VOL- to adjust the brightness of the click wheel.
3. Finally, press Menu to confirm the setting.

7.3 Set Time Format

The time and the display can be indicated in the 12-hour format or 24-hour format.

This function is also available in the standby mode of the device.

1. Press and hold the Menu button of the eklipse or the remote control until the Setup Menu appears.
2. Select the **Clock** menu item and select **Format**. The active time format is indicated with an asterisk.

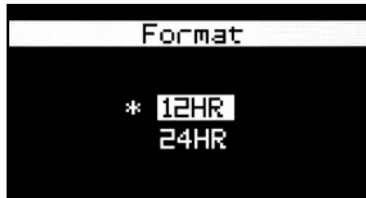

3. Select the desired format and press the Menu button again to confirm the setting.

7.4 Set Time

The time that shows on the display can be set via the Setup Menu.

This function is also available in the standby mode of the device.

1. Press and hold the Menu button of the eklipse or the remote control until the Setup Menu appears.
2. Select the **Clock** setting and select **Time**.

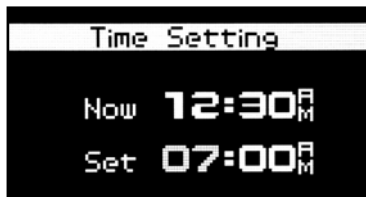

Now shows the currently set time, **Set** shows the time that is to be set.

3. Press the VOL+ or VOL- button to set the hours.
4. Press the Menu button and press VOL+ or VOL- to set the minutes.
5. Press the Menu button again to confirm the setting.

7.5 Set the Sound

The sound of the audio playback can be adjusted via the Bass and Treble setting

1. Press and hold the Menu button of the eklipse or the remote control until the Setup Menu appears.
2. Open the **Audio** menu item.



3. Select **Bass** and press VOL+ or VOL- to adjust the bass sound. Select **Treble** and press VOL+ or VOL- to adjust the treble sound.
4. Finally, push the Menu button again to confirm the setting.

7.6 Set Sleep Timer

The Sleep Timer is a turn-off function that switches the device into the Standby mode after the set time expires.

Turn on Sleep Timer

- To turn on the Sleep Timer, press the SLEEP button. The display will now show the  symbol.
- To turn of the Sleep Timer, press the SLEEP button again. The symbol will disappear.



NOTE!

If the device was turned off via the Sleep Timer, it will start in the last activated listening mode when it will be turned on the next time, e.g. the station (FM/AM) or the title (iPod) that was played last. If the device is supposed to start in the CD mode at that point that was played last, you must first turn on the **Resume** function as described under „Adjust CD Playback“ on page 37.

Set time interval for Sleep Timer

1. To set the length of the time interval press and hold the SLEEP button until the **Sleep Timer** appears.



2. Press the VOL+ or VOL- button to extend or to reduce the time interval until the device will turn off. The maximum time interval is 90 minutes.
3. Press the Menu button to confirm the setting.

When the time has expired, the playback will slowly fade out.

7.7 Reset Device to Factory Setting

If necessary you can reset all implemented settings, such as language and time formats and stored stations to the factory settings.

1. Press and hold the Menu button of the eklipse or the remote control until the Setup Menu appears.
2. Open the **Factory Reset** menu item.

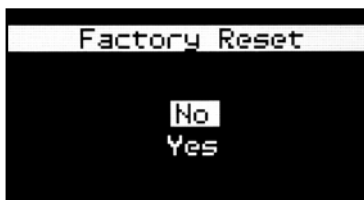

3. Select **Yes** to reset the settings and press the Menu button again to confirm the setting.

8. Alarm Function

With the sonoro eklipse you can set your alarm to play the radio, your favorite CD or your iPod.

All settings are activated via the **Set Alarm** function which can be activated directly via the ALARM button on the top of the device. Alternatively, you can also select the **Set Alarm** function in the Setup Menu.

All alarm functions can also be set while the device is in standby mode.



8.1 Set Alarm Time

1. Press and hold the ALARM button on the top of the device.
2. Select the **Set Time** menu item and press the Menu button.

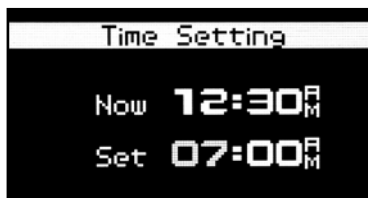

Now shows the currently set time, **Set** shows the alarm time that is to be set.

3. When the hour flashes press the VOL+ or VOL- button to set the time for the hour.
4. Press the Menu button to switch to the minutes and press the VOL+ or VOL- button to set the minutes.
5. Press the Menu button again to confirm the setting.

8.2 Alarm signal via Radio, CD or iPod

1. Press and hold the ALARM button on the top of the device.
2. Select the **Source** menu item and press the Menu button.



3. Selected the desired medium to sound the alarm.

- FM** Press the Vol+ or Vol- button to choose a FM preset from your memory settings, that will start when the alarm goes off.
- AM** Press the Vol+ or Vol- button to choose a AM preset from your memory settings, that will start when the alarm goes off.
- iPod** The iPod starts with the title that was played last.
- CD** The CD starts with the first title on the CD.
If the **Resume** function has been selected in the CD playback, the device jumps to the position on the CD where it left last and plays this during the Alarm mode.
- Beep** The device will wake you up with a classic alarm tone.

The currently selected Alarm mode is displayed on the right side of the display.

4. Press the Menu button to confirm the setting.



NOTE!

If you have selected CD or iPod playback as a source for the alarm, but there is no CD in the device or no iPod connected to it, the device will use the classic alarm tone.

If the device is in Play mode when the alarm is triggered, the alarm tone will also be triggered independent from which source has been selected.

8.3 Set Alarm Volume

1. Press and hold the ALARM button on the top of the device.
2. Select the **Volume** menu item and press the Menu button.



3. Press the VOL+ or VOL- button to turn the volume up or down.



NOTE!

The audio playback always starts with the minimal volume and slowly increases to the set volume.

8.4 Turn Alarm On and Off

- To turn the alarm on, briefly press the ALARM button on the top of the device. The display will now show the  Alarm symbol.
- To turn the alarm off, briefly press the ALARM button on the top of the device again. The alarm symbol will disappear.

Alternatively, you can turn the ALARM on and off via the menu:

1. Press and hold the ALARM button on the top of the device.
2. Select the **On/Off** menu item and press the Menu button.



3. Select the desired setting and press the Menu button again to confirm the setting. The active setting is indicated with an asterisk.

8.5 Turn Off Alarm Function After Alarm Goes Off

- To turn off the alarm, press the ALARM, MENU or STAND-BY button. The alarm stays activated for the next day.
- To activate the repeat alarm function (Snooze), press the SNOOZE button. The remaining time until the alarm sounds again will be indicated on the display. After the set time, the alarm will sound again.

8.6 Set Interval for Repeat Alarm Function (Snooze)

1. To set time period after which the alarm will sound again, press and hold the SNOOZE button, until the **Snooze Setting** appears.



2. Press the VOL+ or VOL- button to extend or shorten the time interval until the alarm goes off again.



NOTE!

You can also set the length of the repeat alarm interval while the Snooze function is active.

9. General Functions of the Audio Playback

Select the respective mode for the audio playback from the different media such as CD, iPod and radio via the MODE button.



The buttons for the title selection, Forward/Rewind, Start, Pause and Stop for CD and iPod function in the same way. This also applies for the buttons on the device as well as on the remote control unit. The special characteristics for the operation of the individual media are described in separate chapters for each medium.

9.1 Set Volume

- To increase the volume, press the VOL+ button on the click wheel.
- To decrease the volume, press the VOL- button on the click wheel.

The volume control will show on the display.

9.2 Mute Playback

- To increase the sound during the playback, briefly press the SNOOZE button on the device while in the Playback mode or press the MUTE/SNOOZE button on the remote control. The following  symbol will appear on the display.
- To turn the sound back on, press the MUTE/SNOOZE again or press VOL+ or VOL-. The  symbol will be displayed again.

9.3 Select Playback Mode

Select the respective mode for the audio playback from the different media such as CD, iPod, radio (FM and AM) or from another external device (AUX).

1. Press the MODE button to open the list of playback modes.
2. Press the MODE button again to switch to the next item on the list.
3. Select the desired mode
4. Press the Menu button to start the selection.

In the mode selection, the display shows the following information:



- 1 Previous mode
- 2 Currently active mode
- 3 Next mode
- 4 Selected mode



NOTE!

During the switch to another mode, the device always starts with the station that played last (FM-, AM mode) or it is at the position where it left off last (CD, iPod mode).

External devices (AUX) are not controlled via the eklipse and therefore always start at the position of the current setting of the device.

10. Radio Playback

1. Turn on the device. The device always starts at the radio station that played last.
2. If the device starts in a different mode, e. g. because it was turned off in a different mode e. g. via the Sleep Timer, press the MODE button and select the FM or AM mode.

In the Radio mode (FM and AM) the display shows the following information:

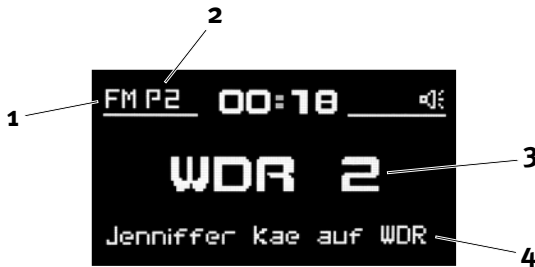

- 1 Mode: FM or AM
- 2 Saved program position if the station was saved in the program memory.
- 3 Station name if the station transmits RDS text
- 4 RDS text if the station transmits RDS text



NOTE!

RDS is only available for stations in the FM frequency range and only if the respective station transmits RDS data

If the station does not transmit RDS text, the frequency will be displayed instead of the name of the station.



10.1 Search Station

- To search for the next station with a strong signal in the low frequency range, press and hold the << (Previous) button on the click wheel until the search process starts on the display.
- To search for the next station with a strong signal in the low frequency range, press and hold the >> (Next) button on the click wheel until the search process starts on the display.
- To manually set a different frequency, briefly pressed the << (Previous) or the >> (Next) button. The frequency will respectively jump by one level.



NOTE!

In case of a weak FM reception you should connect the external FM antenna and make sure that the FM switch on the back of the device is set to the correct position (refer to chapter „Connect Antenna“).

If the reception is still too weak in spite of the external antenna, readjust the antenna or position the device at a different location.

10.2 Preset Station

The sonoro eklipse offers ten program memory settings for every frequency band (FM and AM).

Preset station via the device

1. Set the station that you want to save.
2. Press and hold the FAVOR button on the device until the program memory is opened.

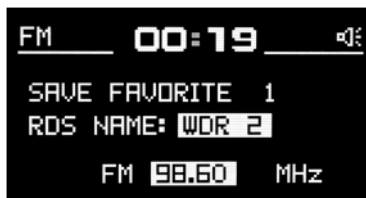

3. Press the VOL+ multiple times until you reach the program position on which the station is supposed to be preset.
4. Press the Menu button. The message „SAVED“ will show on the display.

Preset station via remote control

**NOTE!**

Only the programming positions 1–6 can be preset via the remote control. The program positions 7–10 can only be accessed on the device via the FAVOR button.

1. Set the station that you want to preset.
2. Press and hold the program button (buttons 1–6) onto which you want to save the station until the display shows the message „SAVED“.

10.3 Retrieve Preset Station

**NOTE!**

Only the programming positions 1–6 can be retrieved via the remote control. The program positions 7–10 can only be accessed on the device via the FAVOR button.

Retrieve station via the device

1. Briefly press the FAVOR button on the device. The program memory will be opened.
2. Press the VOL+ or VOL- button until you reach the program position that you want to retrieve.

The selected station is played back and the information is shown on the display.

Retrieve station via remote control

- Briefly press the program button (button 1–6) of the station. The selected station is played back and the information is shown on the display.

11. CD Playback



WARNING!

Physical damage through improper operation!

Do not insert any mini CDs or audio carriers into the CD player that differ from the standard CD formats. Those may potentially not play properly and may not be ejected again.

Only insert one CD at the time into the CD player.

1. Turn the device on and insert the CD into the CD slot with the imprinted side facing up. The CD player automatically pulls in the CD and starts the playback. If the device is in a different mode, the device will automatically switch to the CD mode.

In the CD mode, the display shows the following information:

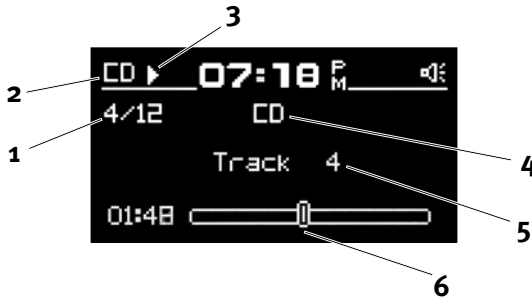

- 1 Title number/ number of titles
- 2 Mode: CD
- 3 Play status (start/pause)
- 4 CD format: CD, MP3, WMA
- 5 Title number or name of the artist and title if the CD contains this information
- 6 Completed play time in minutes as well as in form of progress bar

- To interrupt the playback of the CD (Pause), press the **Start/Pause** button. The display will now show the **CD ||** Pause symbol.
- To continue to play the CD, press the **Start/Pause** button again.
- To switch to the next title, press **Next/Fast-forward** once. To quickly move forward within a title, press and hold **Next/Fast-forward**.
- To switch to the previous title, press **Previous/Rewind** once. To quickly go backwards within a title, press and hold **Previous/Rewind**.
- To end the playback of a CD, press **Stop**. If you play an inserted CD again at a later time by pressing **Start/Pause** the device will start with the title that was played last. This also applies if you have changed the mode in between.
- To eject the CD, press **Eject**.

Adjust CD Playback

To play back the titles on the CD you can select different play sequences.

1. Press and hold the Menu button of the eklipse or the remote control until the Setup Menu appears.
2. Open the **SET CD** menu item.



3. Select a function and press the Menu button to turn on the function.

Repeat: The current title will be played repeatedly. This function will be terminated when you switch the mode or when you eject the CD. Display symbol:

Repeat All: All titles of the CD are played repeatedly. This function will be terminated when you switch the mode or when you eject the CD. Display symbol:

Shuffle: The titles of the CD are played in a random sequence. This also applies if you press **Next/Fast-forward** or **Previous/Rewind**. This function will be terminated when you switch the mode or when you eject the CD. Display symbol:

Resume: The CD playback will continue at the position where it left off the last time, even if you have changed the mode or if the device was switched to standby mode. This function will be terminated when you eject the CD. Display symbol:

12. iPod Playback

1. Turn the device on and insert the iPod into the docking station.
2. Press the MODE button and select the iPod mode.

The display shows the iPod symbol. The iPod is being recharged at the same time.



You can operate the iPod via the buttons of the device or via the remote control. In this case, the buttons correspond with the following iPod buttons:

Function	iPod	eclipse	Remote control
Open Menu Selection	Menu	Stop	Menu
Switch to the next higher menu.	Menu	Stop	Menu
Switch to previous menu setting (up)	Click Wheel	VOL+	VOL+
Switch to previous menu setting (down)	Click Wheel	VOL-	VOL-
Select menu item	Menu button	Menu button	Menu button
Start title	Menu button	Start/Pause Menu button*	Start/Pause Menu button*
Play previous title	Previous/Rewind	Previous/Rewind or <<	Previous/Rewind or <<
Play next title	Next/Fast-forward	Next/Fast-forward or >>	Next/Fast-forward or >>
Pause title	Start/Pause	Start/Pause	Start/Pause

* If you start a selected title via the Start/Pause button, you can control the volume immediately with the VOL+ or VOL- buttons. When you start the title via the menu button of the click wheel, you can only set the volume after 6 seconds when the function of the VOL+ and VOL- buttons have switched from the navigation mode back to the volume control mode.

**NOTE!**

If the Menu Selection is open on the iPod the Vol+ und Vol- buttons serve as navigation buttons. If the iPod menu is not active, they function as volume controls.

- Turn off the iPod or end the iPod playback function.

**NOTE!**

The iPod playback is stopped during the switch into a different mode. When you switch back to the iPod mode the playback can be continued at the position that was played last by pressing the Start/Pause button.

13. AUX Playback

Via the AUX jack on the back of the device, such as e. g. an MP3 player, you can connect from and listen to additional audio devices to the sonoro eklipse.

1. Turn on the sonoro eklipse, press the MODE button and select the AUX mode.
2. Turn on the external device and start the playback on the external device.



NOTE!

It is not possible to operate an external device via the buttons of the sonoro eklipse.

14. Trouble Shooting

All electronic devices may experience malfunctions. This does not necessarily involve a defect on the device. Please check the following table to see if you can solve the problem yourself.

Malfunction	Possible cause	Trouble shooting
Device does not turn on immediately	Power supply plug is not connected properly	Connect the power supply unit properly (refer to chapter „Establish Power Supply“ on page 14).
No sound	Volume is set to minimal	Increase the volume (refer to chapter „Set volume“ on page 31).
	Sound is turned off	Turn on the sound (refer to Chapter „Mute Playback“ on page 31).
	Headset is plugged in	Pull the headset out of the jack.
	A different mode has been set.	Set the correct mode (refer to Chapter „Select Playback Mode“ on page 31).
CD playback does not start	CD format is not supported.	Insert a different CD in the CD slot.
	CD is dirty	Clean the CD.
	CD is damaged	Insert a different CD in the CD slot.
	CD is upside down in the CD slot.	CD is positioned upside down in the CD slot.
iPod playback does not start	iPod is not plugged in	Insert the iPod in the iPod docking station on the top of the device (refer to chapter „iPod Playback“ on page 38).
	iPod type is not supported	Check whether your iPod is compatible with the device (refer to Chapter „Supported Formats“ on page 12).
	iPod does not include any readable audio files	Check the files on the iPod (refer to Chapter „Supported Formats“ on page 12).
Poor FM reception quality	Transmission signal of the station is too weak for internal antenna	Connect the external FM antenna (refer to chapter „Connect Antenna“ on page 15).
	Antenna switch is set incorrectly.	Move the FM antenna switch to the correct position (refer to chapter „Connect Antenna“ on page 15).
	FM antenna is not adjusted properly	Change the position of the FM antenna.

Malfunction	Possible cause	Trouble shooting
Poor AM reception quality	AM antenna not connected	Connect the AM antenna (refer to chapter „Connect Antenna“ on page 15).
	AM antenna is not adjusted properly.	Change the position of the AM antenna.
Remote control does not work or with disruptions	Distance is too far	Reduce the distance between the remote control and the device.
	Battery is empty	Replace the battery of the remote control unit.
	Interference with other wireless devices	Increase the separation between the device and other wireless equipment. Connect the device to a different outlet, or position the device to a different location.
Alarm doesn't work	Alarm is not turned on	Turn on the alarm (refer to chapter „Turn Alarm On/Off“ on page 29).
	Alarm volume is set to minimal	Increase the volume (refer to chapter „Set Alarm Volume“ on page 29).
	Headset is plugged in	Pull the headset out of the jack.

15. Technical Data

Device name	sonoro eklipse AU-3000 and AU-3001
Measurements (width)	approx. 6.3" x 9.3" x 5.5" / 210 mm x 235 mm x 140 mm
Weight	approx. 7.3 lb / 3,3 kg
Weight including packaging	approx. 9.9 lb / 4,5 kg
Remote control	Radio frequency remote control
Power supply plug: FSC Power	Model: CFSD-24120-2000 Input: 100-240 V ~ 50-60 Hz 0.50 A Output: 12 V $\overline{=}$ 2000 mA
VDSO POWERTECH	Model: VA24B-12020 Input: 100-240 V ~ 50-60 Hz 0.7 A Output: 12 V $\overline{=}$ 2 A
Batteries for clock	2 Alkali Manganese batteries: 1.5 V, type LR06/AA (Mignon)
Batteries for remote control	1 Lithium battery: 3 V, type CR2025 (button cell)
Power consumption in standby mode at 230 V~ 50 Hz	approx. 1.5 W (CD Resume off)
Output	approx. 7.5 W RMS, THD 1 % (AUX IN, 0 dB 1 KHz)
Laser	Class 1
Connections	Headset port: 3.5-mm jack, stereo AUX IN port: 3.5-mm jack, stereo LINE OUT port: 3.5-mm jack, stereo FM antenna AM antenna
CD playback formats	Audio-CD, MP3-CD, WMA-CD, CD-R* & CD-RW* (* Playback depends on the CD quality and recording quality)
MP3	Layer 3 of MPEG1, MPEG2 and MPEG2.5 Sampling rate (KHz) : 16, 22,05, 24, 32, 44,1, 48 Bit rate (kbps): 8-320 Supports ID3 tag v1,1, v2 for title/artist display
WMA	WMA vers. 9 Sampling rate (kHz): 48, 44,1, 32 Bit rate (kbps): 32-192

Subject to technical changes!

Declaration of Conformity

Manufacturer: sonoro-audio GmbH & Co. KG

We herewith declares that the sonoro eklipse is in conformity with the EMC directive 2004/108/EC, the LVD directive 2006/95/EC and R&TTE directive 1999/5/EC; with respect to its conception and style of construction as well as its performance as issued by us.



FCC declaration of conformity statement

This device complies with Part 15 of the FCC Rules. Operation is subject to the following two conditions:

- (1) This device may not cause harmful interference; and
- (2) this device must accept any interference received, including interference that may cause undesired operation.



Radio and television interference

This equipment has been tested and found to comply with the limits for a Class B digital device, pursuant to Part 15 of the FCC Rules. These limits are designed to provide reasonable protection against harmful interference in a residential installation. This equipment generates, uses and can radiate radio frequency energy and, if not installed and used in accordance with the instructions, may cause harmful interference to radio communications. However, there is no guarantee that interference will not occur in a particular installation. If this equipment does cause interference to radio or television reception, which can be determined by turning the equipment off and then on, the user is encouraged to try to correct the interference by one or more of the following measures:

- Increase the separation between the equipment and receiver.
- Connect the equipment to a different outlet so that the equipment and receiver are on different branch circuits.
- Consult the dealer or an experienced radio/TV technician for help.

In the case of a modification, unauthorized by sonoro audio GmbH & Co. KG being made to the device, the declaration losses its validity automatically.

The full description of conformity can get from sonoro@aixtema.de.

16. Warranty

The following applies to the filing of warranty claims - without thereby limiting your legal rights:

- Warranty claims may only be asserted within a time period of no more than two years starting with the date of purchase.
- Within the warranty period we will rectify all defects that are based on material or manufacturing defects at our discretion either through repair or a replacement of the device.
- Please contact your authorized dealer or send the defective device together with the warranty card and the proof of purchase to the service address. The repair or replacement of the device will not start a new warranty period. The warranty period of 2 years from the purchase date remains the deciding factor.
- Damages due to improper use, normal wear and tear as well as defects that impact the value or the usability of the device only insignificantly are excluded from the warranty. Procedures that were performed by anyone by a service address authorized by us will also terminate the warranty.



eklipse

Warranty card

Last name

Serial number

First name

Statement of defect

Street address

City / State / ZIP

Phone

E-mail

Signature of customer